

Farman F-4 X

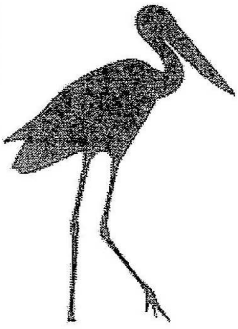

Jabiru

radiateur
balsa et papier

couleur marron rosé

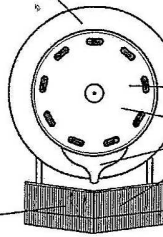

30/10

piqueur 6 à 8°

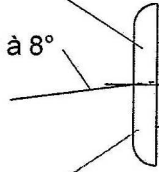

papier

couleur alu

cylindre
balsa 4 mm
couleur cuivre

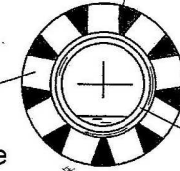

2 fois 5/10
fil en long

bloc balsa

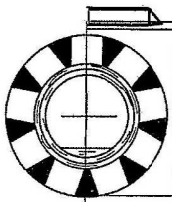
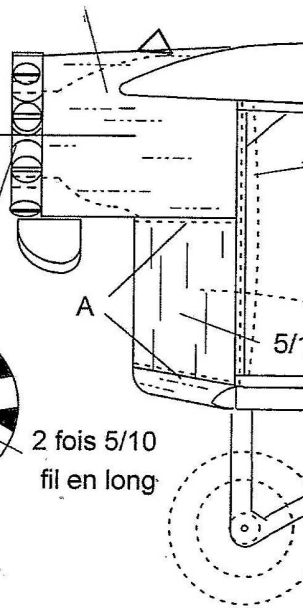

mats 5/10 profilé

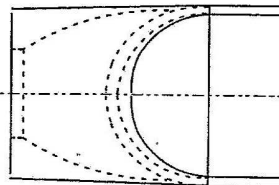
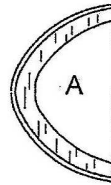

Poids en ordre de vol 13 à 14 g plastique transparent

moteur une boucle de 2,4 à 2,6 mm 350 à 400 mm

hélice de vol

bois vert

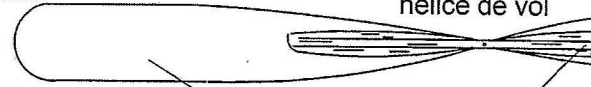

ctp 5/10

cap 5/10

hélice folle à grand pas
pour moteurs latéraux

dégager au beso
pour passage du ca

